

# PRODUCT GUIDE

## Moisture Measurement and Control



**NIR & RF**

# About Sensortech

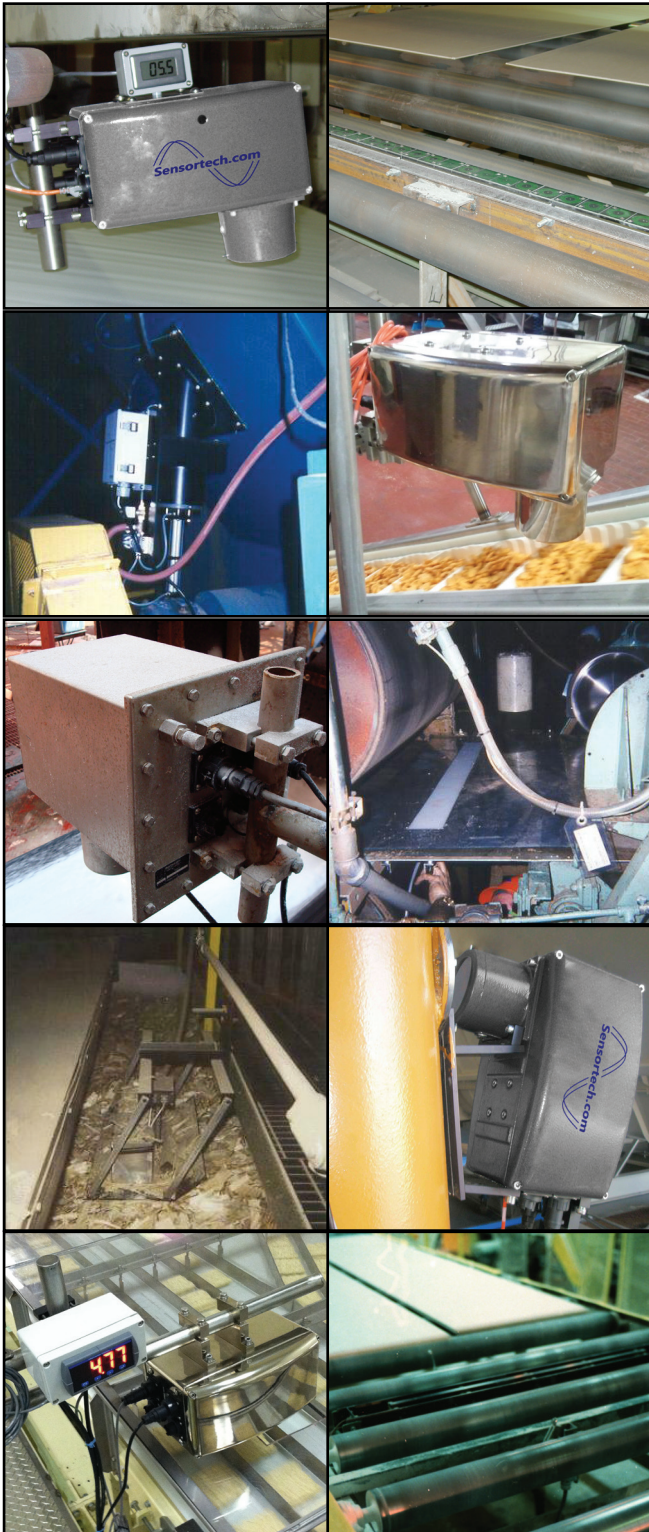

Sensortech Systems, Inc. has been the trusted name in moisture measurement and control for more than 30 years. Incorporated in 1983 Sensortech has become the global leader in applied moisture measurement technologies.

Our instruments can be found in numerous industries throughout the world providing productivity enhancing benefits yielding effective process control and quality assurance. Sensortech's success is due to our leading edge manufacturing processes, comprehensive testing and quality control standards, high performance instruments, diverse range of applications, and superior customer support.

We are a full design, development, and manufacturing facility specializing in Near Infrared Reflectance (NIR) and Radio Frequency (RF) technology. Through our expertise in both disciplines of moisture measurement technologies we apply the correct instrumentation to your process. With Sensortech you know you are getting what you need where you need it.

MOISTURE MEASUREMENT TECHNOLOGY.....	4
PRODUCT OVERVIEW.....	5
NEAR INFRARED SERIES.....	6
NIR SERIES TECHNOLOGY.....	7
NIR MANAGEMENT SOFTWARE.....	8
NIR INDUSTRIAL GRADE SERIES.....	9
NIR FOOD GRADE SERIES.....	10
NIR NARROW BEAM SERIES.....	11
NIR HARSH ENVIRONMENT SERIES.....	12
NIR EXPLOSION PROOF SERIES.....	13
NIR LABORATORY SERIES.....	14
NIR HIGH SENSITIVITY SERIES.....	15
NIR TOBACCO GRADE SERIES.....	16
NIR SPECIAL / OEM SERIES.....	17
NIR SERIES OPTIONS.....	18
NIR SERIES ACCESSORIES.....	19
NIR SERIES SPECIFICATIONS.....	20
NIR SERIES APPLICATIONS.....	21

# Contents

RF SERIES APPLICATIONS.....	22
RF PRODUCT LINE.....	23
RADIO FREQUENCY MOISTURE INSTRUMENTS.....	24
RF MOISTURE MANAGEMENT SYSTEMS.....	25
RF OPEN FRAME PLANAR SERIES.....	27
RF FLANGE MOUNT SERIES.....	28
RF SLED SERIES.....	29
RF PIPELINE SERIES.....	30
RF SAMPLING SERIES.....	31
RF INSTANT MOISTURE PROFILING SYSTEM.....	32
RF PACKMOIST LABORATORY ANALYZER.....	34
RF PORTABLE MOISTURE TESTER.....	35
RF SERIES OPTIONS.....	36
RF SERIES SPECIFICATIONS.....	37
PRODUCT SERVICES.....	40

# Moisture Measurement Technology

Sensortech's comprehensive product line has the capability of measuring moisture across a diverse range of manufacturing environments.

We leverage our expertise in both fields of Near Infrared Reflectance (NIR) and Radio Frequency (RF) to ensure you are using the correct technology for your application.

Our comprehensive product line places the correct moisture measurement technology exactly where you need it.

## Near Infrared Reflectance (NIR) Technology

Near Infrared Reflectance (NIR) technology employs Near Infrared wavelengths to provide a surface measurement of your products moisture composition. A well distributed moisture composition presents an opportunity for a fast, easy, and dynamic measurement of virtually any product.

The NIR Series of moisture analyzers are a Moisture Measurement and Control System designed for the continuous monitoring of your product using Near Infrared Reflectance (NIR) technology. Its rugged design provides accurate, real-time, and non-contact measurements in the most demanding manufacturing environments. The NIR Series joins its precision measurement with Sensortech's Industrial Grade signature.

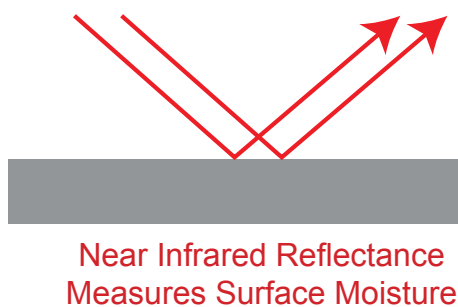

## Radio Frequency (RF) Technology

Radio Frequency (RF) technology uses a Radio Frequency Dielectric Measurement to analyze the moisture composition of your product. The effect of moisture distribution is greatly minimized due to the RF energy deeply penetrating its target providing an accurate measurement of total moisture.

Sensortech's patented line of RF moisture management technologies use the Radio Frequency Dielectric Measurement and have been the standard of excellence for over 30 years. Many of these sophisticated instruments perform in the harshest environments including temperatures up to 1000°F (537°C). It is not uncommon to find these instruments still in use decades after they have been installed.

RF Energy Deeply Penetrates Product Thickness

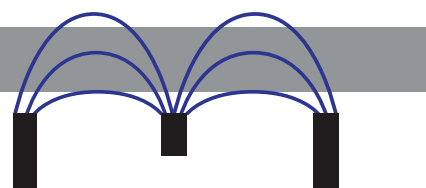

# Product Overview

## NIR SERIES

Sensortech offers the most comprehensive arrangement of specialized NIR moisture analyzers in the globe.

This arrangement had been developed through the implementation of numerous applications across a wide variety of industries each having distinctive requirements. From this experience our Engineering Group has developed 9 distinct classes of applied NIR technology:

1. NIR-6000 Series | **Industrial Grade**
2. NIR-6100 Series | **Food Grade**
3. NIR-6200 Series | **Narrow Beam**
4. NIR-6300 Series | **Harsh Environment**
5. NIR-6400 Series | **Explosion Proof**
6. NIR-6500 Series | **Laboratory**
7. NIR-6700 Series | **High Sensitivity**
8. NIR-6800 Series | **Tobacco Grade**
9. NIR-6900 Series | **Special/OEM**

The NIR Series moisture analyzers offer an array of interfaces that accommodate: water immersion, protection from dust, hazardous environments, severe temperature, and application specific precision. Additionally, we manufacture numerous application interfaces and options designed to integrate the NIR-6000 into your particular manufacturing process.

## RF SERIES

The RF Series of Moisture Management Systems offer unparalleled performance in a broad scope of manufacturing environments.

Over 40 instruments having a variety of geometries and sizes are available to accommodate your specific manufacturing requirements. Each of these varieties of instruments are classified into one or more of the following 8 series of RF technologies:

1. **Open Frame Planar Series**
2. **Flange Mount Series**
3. **Sled Series**
4. **Pipeline Series**
5. **Sampling Series**
6. **Instant Moisture Profiling System**
7. **PACKMOIST**
8. **Portable Moisture Tester**

### ST-2200A

The ST-2200A is the management system for the *Open Frame Planar, Flange Mount, Sled, Pipeline, and Sampling Series*. These Series operate as application interfaces for the ST-2200A but are radically different technologies used for radically different applications.

### ST-3300

The ST-3300 is an expanded variation of the ST-2200A that uses the same Series of RF application interfaces but includes a number of powerful functionalities.

# Near Infrared Series



# NIR Series Technology

**N**IR Series analyzers have been adapted to an assortment of specialized applications offering a wide range of products within each discipline of NIR technology. At Sensortech, we recognize that every manufacturing process is unique and your needs are no exception. Innovative application interfaces, options, and applied NIR technology is available to accommodate your specific requirements.

## ENGINEERED QUALITY & DURABILITY

Sensortech is unique in its ability to deliver dependable performance through its advanced NIR technology, leading edge manufacturing processes, and comprehensive testing and quality control standards. An emphasis on durability has been placed on the NIR Series during its development in order to bring Sensortech's high standard of performance to industrial applications.

## PROCESS CONTROL

Every analyzer in the NIR Series is equipped with a variety of communication protocols designed to operate fit in your distributed process control system. Moreover, each analyzer may operate independently with Sensortech's Digital Panel Meter (DPM), Touch Operator Interface (OI), or third party peripheral devices.

## SOFTWARE DIAGNOSTICS

Intuitive Management Software provides an added benefit to the functionality of every analyzer. Our proprietary software package easily installs on your PC and offers an accelerated view of your production process. Among the many features of this powerful software package include: general measurement readings, data-logging, calibration utilities, and analyzer configurations.

## NEAR INFRARED REFLECTANCE

Sensortech filters a quartz halogen light source into a series of pulses of specific wavelengths. The filtered beam of wavelengths is directed onto the surface of your product and measures the reflected energy against a reference source. The constituent being measured, typically moisture, is calculated through a specialized amplitude ratio algorithm providing a precision measurement based on your products molecular structure.

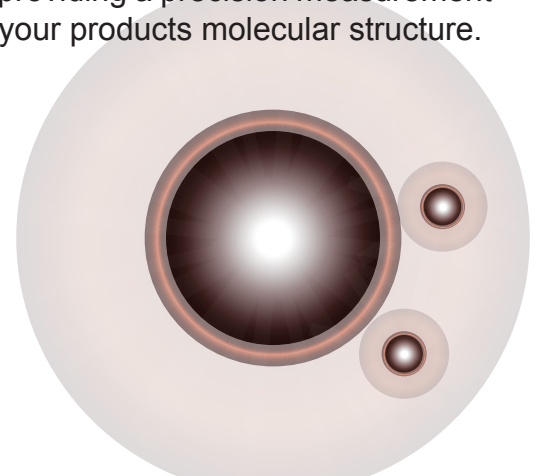



# NIR Management Software

Sensortech's software diagnostics package offers an expansive range of management resources. These resources provide the ability to configure your analyzer for optimal performance and to thoroughly monitor and analyze your manufacturing process.

## MEASUREMENT DISPLAY

The NIR Management Software supplies an operator with the capability of monitoring up to three measured constituents in addition to a temperature display. A trend plot is displayed for a visual convenience giving the ability to immediately spot production issues and to take corrective action.

## CALIBRATION UTILITIES

The calibration utilities allow you to adjust, fine-tune, or recalibrate your analyzer. It is recommended to consult Sensortech for guidance when employing this powerful feature.

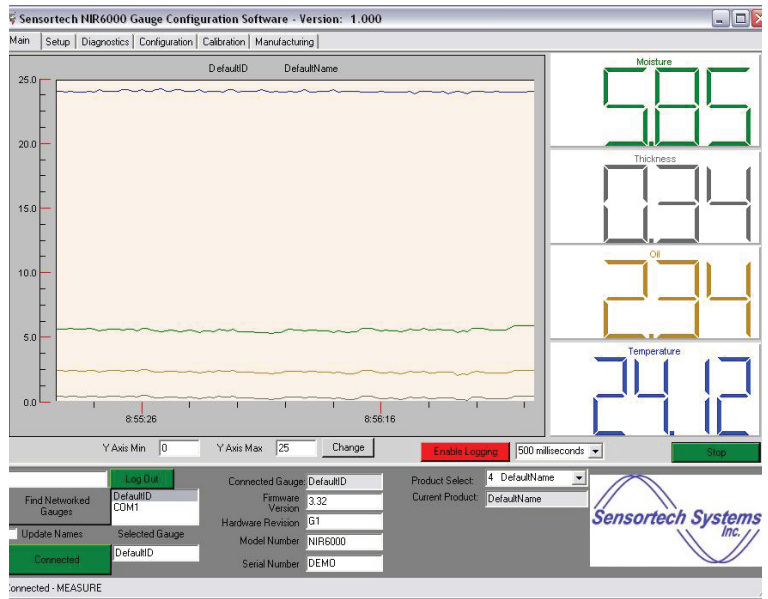

## DATA-LOGGING

Data-logging is a useful tool for engineers requiring historical data for statistical analysis. The measurement data is saved to a file that can be viewed by Microsoft Excel or similar programs.

## ANALYZER CONFIGURATION

Many features of the Management Software are dedicated to configuring your analyzer to your requirements. Configurations such as setting the communication protocols, measuring methods, sampling settings, scaling parameters, measurement damping and filtering, and network parameters are among the features available in the Management Software. You have the option to save your configuration settings to a file and reload it at a later date.

Additionally, you may store up to 50 separate product calibrations using any of the available constituents pre-installed on your analyzer.

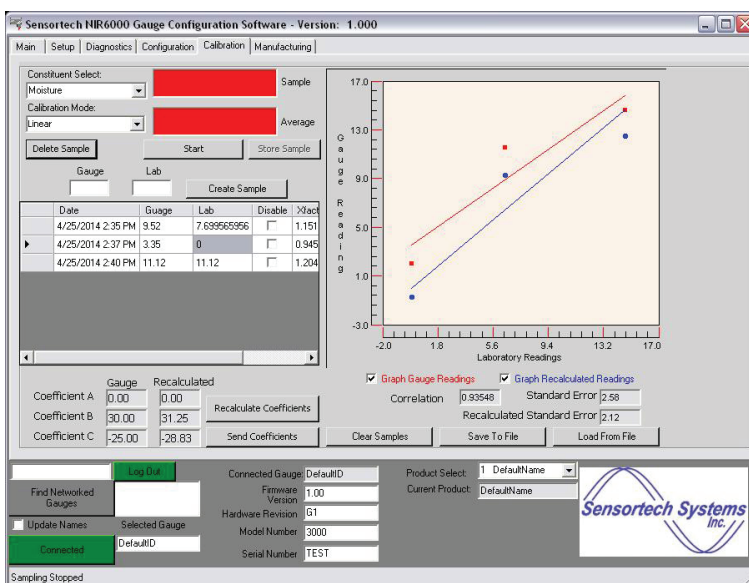

# NIR Industrial Grade Series



## Typical Industries:

- Biomass
- Chemicals
- Food Processing
- Forest Products
- Minerals
- Paper Processing
- Plastics
- Textiles
- Tobacco

## Standard Constituents:

- High Moisture
- Low Moisture
- Coating Weight
- Thickness
- Oil
- Protein
- Nicotine
- Others

## Process Locations:

- Belt Conveyors
- Conveyor Drop-Off Points
- Down Chutes
- Drag Conveyors
- Fluid-Bed Dryers
- Hoppers
- Laboratory
- Roller Conveyors
- Screw Conveyors
- Storage Bins

The NIR-6000 Series of On-Line NIR Moisture Analyzers offer precision measurement and moisture control for industrial applications. Sensortech has pioneered industrial applications of moisture measurement technology for over thirty years and the NIR-6000 Series of moisture analyzers packages the latest NIR technology into a sophisticated instrument engineered for durability and precision measurement. It has been designed to provide accurate readings using the molecular structure of your product and to deliver an effective contribution to your process control.

It's dynamic technology and easy installation provides significant cost saving and productivity enhancing benefits. The range of communication protocols, intelligent sampling methods, and software utilities of the NIR-6000 Series facilitate the integration of moisture management into your process control system.

## PRIMARY BENEFITS:

Effective Process Management

Increase Product Consistency

Improve Quality Control

Reduce Product Waste

Reduce Energy Costs

Increase Overall Productivity

# NIR Food Grade Series

The NIR-6100 Series of On-Line NIR Moisture Analyzers are designed for food grade applications. The nickel plated surface provides additional protection from corrosion and largely eliminates the risk of abrasion and issues related to the porous nature of standard metallic enclosures. Its NEMA 4X rating allows light wash-downs, and promotes a high level of protection from contamination, bacteria, and other hazards typically associated with food processing.

It is ideally suited for food processors concerned about regulatory compliance or simply wanting a higher standard for their food application. The non-contact characteristic of Sensortech's NIR Series reinforces your processes standard of cleanliness and hygiene while maximizing productivity by reducing downtime with its maintenance-free operation. The NIR-6100 bridges the gap between productivity and health code compliance.

## ADDED BENEFITS:

Promote Sanitary Environment

Increase Product Quality

Reduce Water Consumption

Support Regulatory Compliance

Increase Product Shelf Life

Boost Profitability



## Applications Include:

- Almonds
- Beet Pulp
- Candy
- Cashews
- Cereal
- Cheese
- Chocolate
- Citrus Pulp
- Coffee
- Cookies
- Corn Chips
- Corn Meal
- Crackers
- Flour
- Grains
- Milk Powder
- Milled Products
- Peanuts
- Pecans
- Pet Foods
- Potato Granules
- Potato Powder
- Pretzels
- Soy Beans
- Spent Grains
- Sugar
- Tea
- Tortillas

SEE HARSH ENVIRONMENT  
ANALYZER FOR  
AGGRESSIVE FOOD GRADE  
REQUIREMENTS

# NIR Narrow Beam Series



The NIR 6200 Series serve a specialized purpose for manufacturers having specific application requirements. The optics structure of the NIR 6200 Series has been designed for products needing a higher level of resolution, measuring small target areas, or for translucent products. Many applications of this specialized NIR technology include it being mounted on a scanning frame used to measure the cross profile of webbed products.

The image shown on the left illustrate the NIR 6210 which has been designed for translucent products such as sausage casings. The NIR 6210 is equipped with a special transmission application interface through which the product passes through the legs of the transmission path giving a high resolution measurement of the translucent product.

## ADDED BENEFITS:

High Resolution Measurement

Translucent Products

Concentrated Target Area

Wide Area Measurement

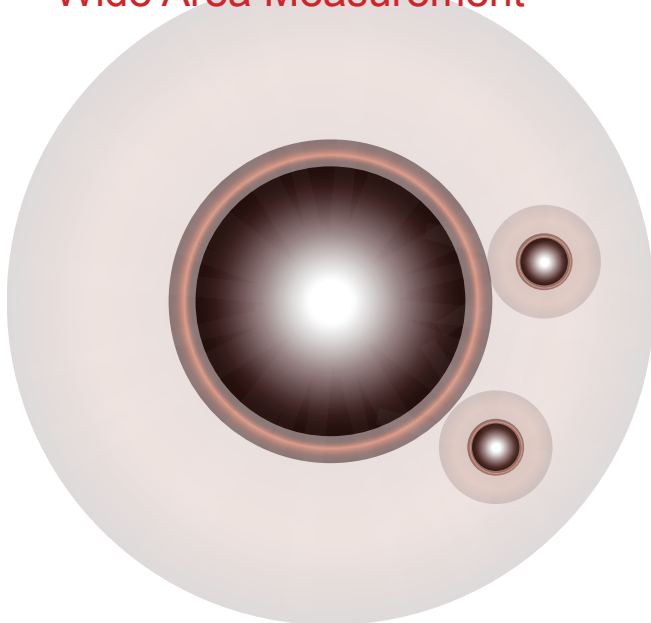

## Scanning Frame Mount

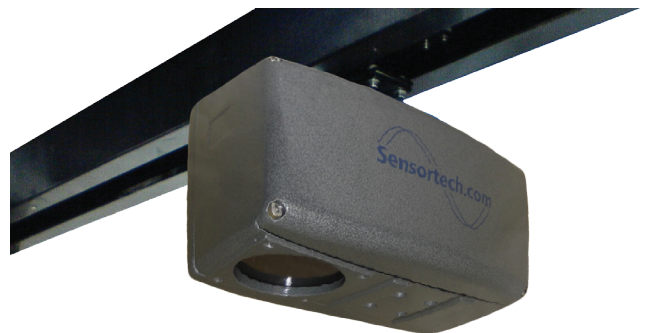

Mounting an NIR 6200 to a scanning frame enables the analyzer to measure across a greater area of your production line. This is particularly useful for applications not suited for RF technology but requiring a wide area measurement.

# NIR Harsh Environment Series

The IP67 rating of the NIR-6300 Series has been developed to withstand severe wash-downs, excessive dust environments, and to protect it against the effects of immersion. Its rugged stainless steel enclosure makes it ideal for harsh environments, high temperatures, and aggressive food grade applications.

The Harsh Environment Analyzer's standard features include an integrated liquid or air vortex cooling system that is rated from 0 to 85°C. A number of options, depending upon your specific application, are available contingent upon your environmental operating temperature and whether or not it is a food grade application.

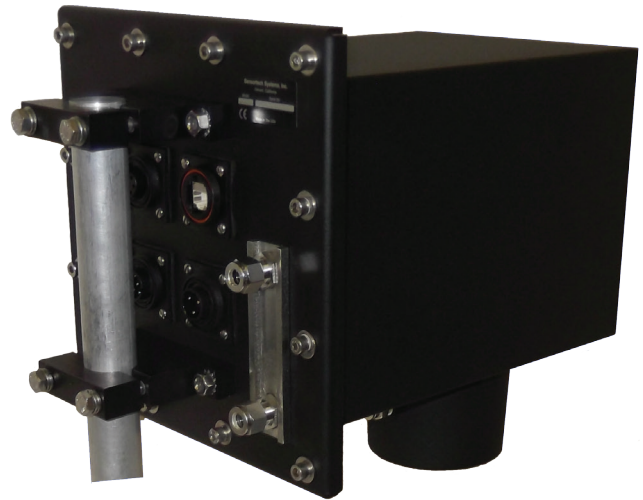

## Aggressive Food Grade Applications

The Harsh Environment Analyzer is an ideal solution for food processors operating in high temperature environments. The stainless steel enclosure provides the highest level of protection essential to food grade applications. The IP67 rating permits the analyzer to operate in environments having excessive dust where the feasibility of performance for the 6100 Series is limited.

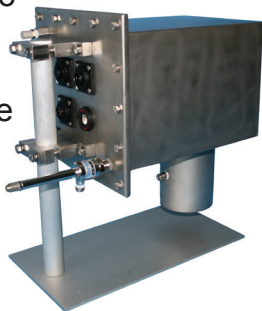

## ADDITIONAL PROTECTION:

- Extreme Temperatures
- Excessive Dust & Debris
- Severe Wash-Downs

## ADDED FEATURES:

- Stainless Steel Enclosure
- Food Grade Applications
- Integrated Cooling System
- Reinforced Protection
- Insulating Options

# NIR Explosion Proof Series

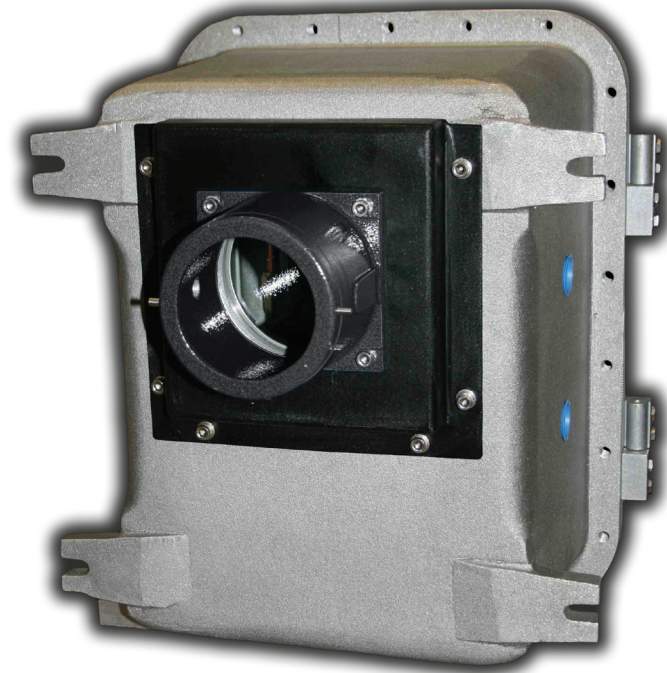

## CLASS I LOCATIONS

The NIR-6400 is designed for Class I Division I environments where explosive gases, mists, or vapors are present under normal operating conditions. It possesses a heavy cast-metal enclosure, is NNNY certified, and ATEX compliant upon request.

## CLASS II LOCATIONS

The NIR-6410 is designed for Class II Division I environments where combustible dust is present under normal operating conditions. It is equipped with a pressurization/purging system, is ATEX compliant upon request, and is suitable for Class III Division I environments.

The Explosion Proof Series of NIR moisture analyzers provide an advanced level of protection from hazardous environments and meet the compliance standards of most regulatory bodies. The NIR-6400 Series is suited for Class I, II, and III hazardous locations, as defined by the National Electrical Code®, and is accompanied with the appropriate certificates required of the classification including the nameplate indicating the distinct classification for which it has been approved.

Sensortech's NIR-6400 Series of Explosion Proof moisture analyzers satisfy a unique manufacturing requirement in hazardous environments where flammable gases or vapors, combustible dust, and easily-ignitable fibers are present. We are specialists in these sensitive manufacturing environments and provide quality performance where it is needed most.

## HARSH ENVIRONMENTS:

Extreme Temperatures

Excessive Dust & Debris

## HAZARDOUS LOCATIONS:

Flammable Gases, Mists, or Vapors

Combustible Dust or Fibers

Explosive or Ignitable Materials

# NIR Laboratory Series

The NIR-6500 Series of NIR Laboratory Moisture Analyzers facilitate methods of experimentation, testing, research, and analysis in controlled environments. NIR Laboratory Moisture Analyzers can be used independently or in conjunction with Sensortech's process or hand-held instruments.

Simply placing your product sample in the test bed or turn-table interface provides a static measurement isolated from variations caused by manufacturing environments. The NIR-6500 Series Analyzers are ideally suited for benchmarking your production process or for autonomous product analysis.

## HIGH SENSITIVITY APPLICATIONS

### NIR-65X7 Series

The NIR-65X7 Series places the NIR-6700 high sensitivity technology into a laboratory instrument. Performing precision laboratory analysis on chemicals and minerals such as sinter mix, coke, coal, detergents, and fertilizers is possible using the NIR-65X7 Series.

## TOBACCO APPLICATIONS

### NIR-65X8 Series

The NIR-65X8 Series integrates the optimized NIR-6800 technology used for tobacco applications to our laboratory series of analyzers. This combination of technologies introduces all the benefits associated with a laboratory analyzer to tobacco applications.



## Applications Include:

### Food Products

- Candy
- Grains
- Granules
- Nuts
- Pet Foods
- Powders
- Pulps
- Snack Foods

### Wood Products

- Bark
- Hog Fuel
- MDF & OSB
- Biomass
- Pellets
- Raw Material
- Resin
- Shavings

### Tobacco

- Chewing Tobacco
- Cigar Tobacco
- Cut Tobacco
- Filler
- Snuff
- Reconstituted Tobacco
- Whole Leaf Tobacco
- Whole Stems

### Chemicals & Minerals

- Acetate
- Cellulose
- Cement
- Ceramics
- Chalk
- Crushed Coal
- Detergents
- Laminated Glass
- Plastics
- Sand
- Sinter Mix
- Various Minerals

# NIR High Sensitivity Series



## ADDED FEATURES:

High Sensitivity Hardware

Application Specific Calibrations

Applied Environmental Durability

## Applications Include:

- Acetate
- Bauxite
- Cellulose
- Cement
- Ceramics
- Chalk
- Crumb Rubber
- Crushed Coal
- Detergents
- Fiberglass
- Foundry
- Iron Ore
- Laminated Glass
- Plastic Chips
- Plastic Powders
- PVB Sheet
- PVC
- Sand
- Sinter Mix
- Soap Flakes
- Soap Powder
- Many Others

## MINERAL & CHEMICAL APPLICATIONS

Particular applications having low optical reflectance properties are ideally suited for the NIR-6700 Series moisture analyzers. These High Sensitivity analyzers provide exceptional performance in the most demanding manufacturing environments and offer unmatched precision on materials normally unreceptive to NIR measurements.

The NIR-6700 Series has optimized Sensortech's NIR technology for mineral and chemical applications using high sensitivity hardware, regulated gain stage configurations, and application specific calibration standards. Maximizing sensitivity for these low reflectance applications have given the NIR-6700 the ability to provide accurate measurements for the most difficult applications.

## Laboratory NIR-65X7 Series

Sensortech has packaged the NIR-6700 Series technology into a laboratory analyzer providing the ability to perform product analysis, testing, and research on chemical and mineral applications.



**Refer to the NIR-6500  
for additional details**



# NIR Tobacco Grade Series

## TOBACCO APPLICATIONS

The NIR 6800 Series has been developed to address the specialized requirements of tobacco processing. From harvest to packaging the NIR-6800 Series satisfies these requirements of tobacco processing. Measurement and control of moisture, nicotine, sugar, and other constituents is an essential prerequisite for high quality tobacco products. Sensortech has optimized the NIR 6800 Series to accurately measure these constituents throughout the production process of tobacco in its many forms.

Optimizing NIR technology for tobacco applications is a rigorous process requiring an exact optical sensitivity range, precision wavelength filtering, and application specific calibration techniques. Coupling these methods of optimization with Sensortech's innovative NIR technology produces a sophisticated instrument yielding unmatched measurement and control for tobacco applications.

### Applications Include:

- Bright/Burley
- Chewing Tobacco
- Cigar Tobacco
- Cut Lamina
- Cut Tobacco
- DIET
- Expanded Tobacco
- Filler
- Lamina Strips
- Pipe Tobacco
- Reconstituted Tobacco
- Snuff
- Whole Leaf Tobacco
- Whole Stems



### Measured Constituents:

- Moisture
- Nicotine
- Sugar
- Protein
- Cellulose
- Oil

### Laboratory NIR-65X8 Series

The NIR-65X8 Series laboratory analyzer provides added precision measurement capabilities in controlled laboratory environments. Optimized NIR technology for tobacco applications in a laboratory analyzer is particularly useful for tobacco processors needing comprehensive product analysis.



**Refer to the NIR-6500 for additional details**

## SYSTEMS INTEGRATION

Sensortech's NIR technology is a valuable resource for industrial manufacturers requiring a system of measurement and control within their product. The NIR 6900 Series serve as a critical component of your distributed system offering a powerful arrangement of synergy. It's compact and lightweight design fits comfortably in tight locations and provides valuable data used for numerous purposes.

### Standard NIR Features:

32-bit Processing

Digital Noise Filtering

Surface Mount Technology

Digital I/O for Measurement & Control

Communication Protocols:

- 3 Isolated 4-20mA Outputs
- Ethernet TCP/IP
- RS-232/422/485

## CONTACT SENSORTECH

- Collaborative Opportunities
- Additional Options, Features, and Functionalities
- Detailed Technical Specifications

### INTELLIGENT SAMPLING

The NIR Series is equipped with a number of sampling methods that provide a variety of measurement techniques designed for your system requirements.

Sampling Methods Include:

1. Continuous non-interrupted sampling.
2. Signal Gated Sampling uses an external gating input to start and stop sampling and holds the last measurement.
3. Auto Gated Sampling where the measured moisture level is used to start and stop the measurement using user defined moisture thresholds.
4. Timed Sampling may be used in conjunction with fill and purge techniques of sampling.
5. Gate Timed Sampling uses an external gating input to start and stop sampling for a timed interval.
6. Auto Reference Sampling uses a measured value that is stored as a zero value offset.

# NIR Series Options

Sensortech is a full design, development, and manufacturing facility having a considerable number of options available to suit your requirements. The example shown to the right is our Snorkel Sampler option used for intermittently sampling your product and is controlled through your choice of the NIR Series Intelligent Sampling methods. The examples below are some of our more popular options:



## CONSTITUENTS

Constituents are defined as a measured property of your product. The NIR Series can be configured to measure up to three constituents. The most common constituent the NIR Series is used to measure is moisture. Measured constituents include:

- Low Moisture
- High Moisture
- Coating Thickness
- Cellulose
- Hydrocarbon
- Nicotine
- Phenolic Resin
- Polyethylene
- Polypropylene
- Protein
- Sugar
- Urea

## APPLICATION INTERFACES

The NIR Series offer numerous application interfaces designed for specialized purposes. Among these application interfaces include:

- Air Purge Light Tubes
- Snorkel Samplers
- Probes
- Flange Mounts
- Turn-Table Samplers
- Porthole Interfaces
- Pyrometers

## COMMUNICATION PROTOCOLS

The NIR Series standard features of communication include three self-powered isolated 4-20mA outputs, Ethernet TCP/IP, RS-232, and RS-422/485 protocols. Optionally, the NIR Series offers a number of additional communication protocols:

- PROFIBUS
- PROFINET
- DeviceNet
- EtherNet/IP
- Modbus

## TEMPERATURE CONTROL

Many environments where the NIR Series are used exceed its normal operating temperature. A number of options are available to increase the operating temperature range limit. Among these options include:

- Air Cooling
- Liquid Cooling
- Heating

**CONTACT SENSORTECH FOR ADDITIONAL OPTIONS**

# NIR Series Accessories

The NIR Series of Moisture Analyzers have a variety of accessories used to complement the moisture control of your production process. Among our most popular accessories include the Operator Interface (OI) and the Digital Display (DD).



## OPERATOR INTERFACE (OI)

The OI is an intelligent interactive display used to interface to your NIR Series Moisture Analyzer. It features a range of administrative controls, diagnostic tools, and moisture management settings that provide real-time access to your analyzer's central functions while it is in operation. The OI display has a touch interface and runs on a Windows CE operating system.



## DIGITAL DISPLAY (DD)

The DD is a digital panel meter commonly used as a visual indication of your processes moisture control status. It serves as a simplified solution to operators monitoring key performance indicators. The DD can be mounted in a variety of locations giving the flexibility to supervise your process where you need it the most. The DD includes optional user configurable alarm outputs and min/max limits.

## MISCELLANEOUS ACCESSORIES

Sensortech offers a broad scope of accessories satisfying a range of user requirements. Among these accessories include the following: Calibration Check Standards with case, Base and Stand for on-line Moisture Analyzers, Spare Parts Kit, etc...

**CONTACT SENSORTECH FOR ADDITIONAL ACCESSORIES**

# NIR Series Specifications

NIR Constituents	1,2 or 3
Ranges and Absolute Accuracy (All accuracies subject to application)	
Moisture	0-95% ± 0.10%
Fat	0-75% ± 0.20%
Protein	0-70% ± 0.15%
Total Sugar	0-30% ± 1.00%
Nicotine	0-6% ± 0.10%
* Contact Sensortech for other constituents	
Measurement Distance	1.5 - 16 in. (3.81 - 40 cm)
Optical Sampling Size	1.46 in. (3.70 cm)
6200 Series	0.39 in. (1.00 cm)
Number of Calibrations	50
Standard Weight	16 lbs. (7 Kg)
* Non-Standard enclosures are subject to application.	
Enclosure	
Standard	Cast Aluminum
6100, 6300 & 6500 Series	Stainless Steel
6400 & 6900 Series	Subject to application
Dimensions	Refer to diagrams below
Power	80 / 260 VAC (50 / 60 Hz)
Option	24VDC
Temperature Control	
Standard Operating Temperature	32 - 131°F (0 - 55°C)
6300 Series	32 - 185°F (0 - 85°C)
* Several options are available spanning and exceeding the minimum and maximum stated specifications. Contact Sensortech for details.	
Analyzer Inputs / Outputs	<ul style="list-style-type: none"> <li>• Three self-powered isolated 4 - 20mA outputs</li> <li>• Ethernet TCP/IP, RS-232, RS-422/485</li> <li>• 1 Digital Input</li> <li>• 1 Digital Output</li> </ul>
Communication Interface Options	PROFIBUS, PROFINET, DeviceNet, EtherNet/IP, Modbus
Warranty	2 year system guarantee Lamp and Motor (Lifetime)

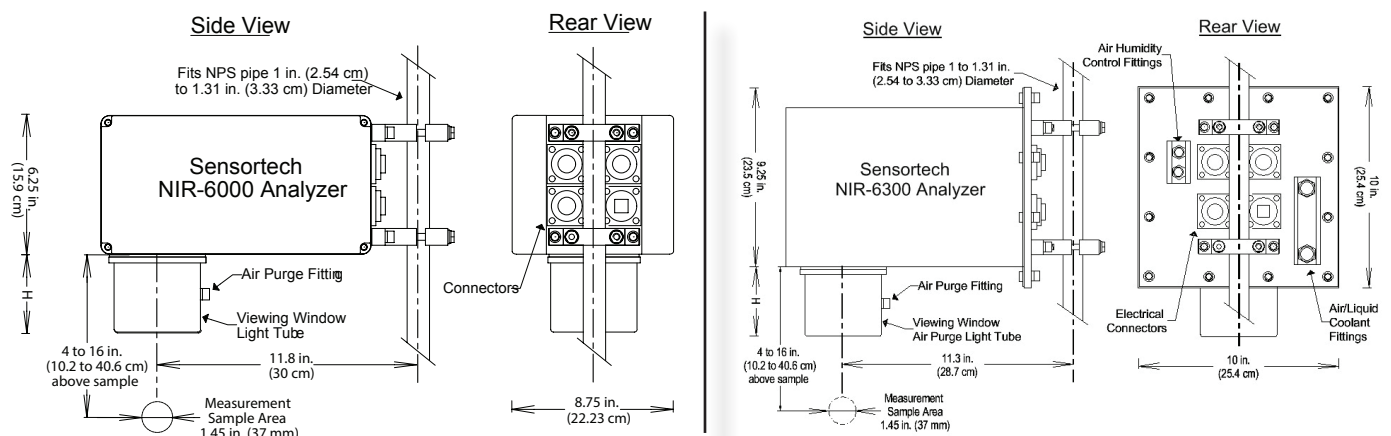

# NIR Series Applications

## TYPICAL INDUSTRIES

Bio-Mass	Paper Processing
Chemical	Plastics
Food Processing	Textiles
Forest Products	Tobacco
Minerals	

The NIR Series Moisture Analyzers play a critical role in optimizing process control standards spanning virtually every industry. Drawing each measurement from the molecular structure of your product allows Sensortech's NIR technology to be used in this broad variety of industries.

## PRODUCT TYPES

Composite Materials	Sensitive Materials
Granular Materials	Sheeted Products
Milled Products	Synthetic Materials
Organic Materials	Translucent Products
Powdered Products	Treated Products
Product Coatings	Webbed Products

Sensortech's NIR technology takes its measurements from the surface of a product having an evenly distributed measured constituent. Products having this evenly distributed composition appear in many forms providing a large diversity of applications across a varied range of product types.

## MEASURED CONSTITUENTS

Low Moisture	Oil
High Moisture	Phenolic Resin
Coating Thickness	Polyethylene
Cellulose	Polypropylene
Hydrocarbon	Protein
Lactose	Sugar
Nicotine	Urea

NIR technology is primarily used for the measurement and control of moisture in a number of applications. Additionally, the NIR Series Analyzers can measure many other properties of your product. If the constituent you are looking to measure has an absorption band within the near-infrared spectrum, the NIR Series can measure it.

## MANUFACTURING ENVIRONMENTS

Controlled Environments	High Temperatures
Excessive Debris	Low Temperatures
Explosive or Ignitable Materials	Light to Moderate Environments
Flammable Gases, Mists, or Vapors	Limited Product Flow
Harsh Environments	Severe Wash-Downs

The NIR Series operates in a variety of manufacturing environments. Each series of NIR instruments has been engineered for durability and precision measurement relating specifically to a broad scope of specialized applications and extreme environments.

## PROCESS LOCATIONS

Belt Conveyors	Laboratory
Conveyor Drop-Off Points	Planar Surfaces
Down Chutes	Roller Conveyors
Drag Conveyors	Screw Conveyors
Fluid-Bed Dryers	Storage Bins
Hoppers	

The NIR Series are intrinsically equipped to be mounted in nearly every location in your production process. The NIR analyzers are simple to install and easy to operate giving the flexibility to place its productivity enhancing benefits where it is needed most.

# RF Series Applications

		TYPICAL INDUSTRIES	
<p>Sensortech's RF Series of moisture measurement and control systems have been applied to many industries throughout the world for over 30 years. Industry demand for these instruments is due, in part, to their ability to exceed performance expectations unavailable with any other technology.</p>	Board Manufacturing	Paper Processing	
	Construction Material	Textile Manufacturing	
	Food Processing	Tobacco Manufacturing	
	General Manufacturing	Wood Manufacture	
	Gypsum Industry		
		PRODUCT TYPES	
<p>The Radio Frequency Dielectric Measurement technique of moisture measurement deeply penetrates your product. This technique of moisture measurement produces the capability of measuring a diverse range of product types. Products having a relatively consistent level of density are ideally suited for the RF Series of moisture analyzers.</p>	Board Products	Organic Materials	
	Composites	Pastes	
	Confectionery Products	Powders	
	Fluids	Raw Materials	
	Granulars	Sheeted Products	
	Milled Products	Synthetic Materials	
		LEADING APPLICATIONS	
<p>A few examples of popular applications are shown to the right. Measuring the moisture composition of your product using Sensortech's patented RF technology is commonly applied to many applications within each category of product types. Sensortech will be happy to assist you with any questions relating to your specific application.</p>	Ceiling Tiles	Mineral Board	
	Dimensional Lumber	OSB	
	Fiberglass	Particleboard	
	Fudge and Molasses	Plywood	
	Gypsum Board	Veneers	
	Hardwood and Board	Whole Leaf Tobacco	
	MDF	Whole Nuts & Grains	
		MANUFACTURING ENVIRONMENTS	
<p>Sensortech's instruments are designed to integrate into the most demanding manufacturing processes. The environment in which your production process operates is among the many factors that have been taken into consideration during the engineering and design of the RF Series.</p>	Controlled Environments	Light to Moderate Environments	
	Excessive Dust & Debris	Limited Product Flow	
	High Temperature	Severe Wash-Down Environments	
	High Vibration Environments	Ultra High Temperatures	
		PROCESS LOCATIONS	
<p>The RF Series of moisture measurement technologies exceeds 40 styles of application interfaces designed to fit into a variety of process locations. These locations range from simple installations to highly complex process integrations. Every manufacturing process is unique and our extensive range of application interfaces are designed to meet your specific requirements.</p>	Belt Conveyors	Laboratory	
	Conveyor Drop-Off Points	Pipeline Framework	
	Hoppers	Post-Production	
	Horizontal & Vertical Planar Surfaces	Roller Conveyors	
	In-Kiln / In-Dryer	Sloping Planar Surfaces	

# RF Product Line

**M**anufacturers having moisture management requirements for materials possessing an irregular moisture composition have a number of options to consider using Sensortech's RF Series of Moisture Management and Control Systems.

## Moisture Management Systems

### Open Frame Planar Series

The Open Frame Sensor is positioned underneath your product in a non-contact arrangement. Its open frame structure allows loose product to fall through it; minimizing buildup.

### Flange Mount Series

The Flange Mount Sensor is fixed in place using a flange mount and is placed in critical points throughout your production process.

### Sled Series

The Sled Sensor hangs from hinged arms allowing it to maintain a parallel position to the conveyor and to level the product for constant measurement.

### Pipeline Series

The Pipeline Sensor is made up of a pipe with attached sensor electronics that is integrated into the pipeline framework of your production process.

### Sampling Series

The Sampling Sensor fills and purges a sampling tray or chamber where the moisture measurement is taken.

## Instant Moisture Profiling System

The *IMPS-4400* is an Instant Moisture Profiling System (IMPS) that employs an array of 2 inch Radio Frequency Dielectric Sensors used to relate directly to the moisture content of your product. This array can span a wide area allowing up to 128 sensors to provide penetrating measurement of the moisture composition of your product.

It is equipped with a powerful set of software tools used for comprehensive data logging and statistical analysis that provides a real-time moisture profile of manufacturing lines having multiple-decks and multiple-products. Optionally, the IMPS-4400 comes with an I/O module that provides moisture data outputs to your Plant Master Control Panel.

## PACKMOIST

The *PACKMOIST* Laboratory Moisture Analyzer is a specialized instrument designed to provide precise moisture measurements of 20 cigarettes in a controlled environment.

## Portable Moisture Tester

The *PMT-330* is a hand-held portable moisture tester commonly used for spot checking the moisture composition of your product in various areas of your manufacturing process.



# Radio Frequency Moisture Instruments



# RF Moisture Management Systems

## ST-2200A

Sensortech's ST-2200A Moisture Measurement and Control System is designed for continuous monitoring of moisture composition in harsh environments where extreme temperatures, severe vibration, and excessive dust or debris typically exclude the use of other moisture analyzers. The ST-2200A uses a proprietary Radio Frequency Dielectric Measurement to analyze the moisture composition of your product. In contrast to the surface measurement techniques of Near Infrared Reflectance (NIR) the RF energy deeply penetrates the product minimizing the influence of moisture distribution. Sensortech produces more than 40 application interface styles to satisfy most manufacturing locations and requirements. The ST-2200A provides an advanced level of stability, repeatability, and precision measurement regardless of environment and product complexity.



## ST-3300

The ST-3300 builds on the strengths of the ST-2200A integrating many of the communication protocols and software attributes contained in the NIR Series Analyzers. In addition to the standard I/O features of the ST-2200A the ST-3300 includes Ethernet TCP/IP and optional PROFIBUS, PROFINET, DeviceNet, and EtherNet/IP communication protocols. A powerful management software package is included with the ST-3300 used for general configuration, intelligent sampling control, and setting network parameters.

## RF Series Application Interfaces

One of five types of application interfaces are used with the Moisture Management Systems. Broad variations within each series of application interfaces are available depending upon your process requirements. These variations combine to total over 40 styles of Moisture Management Systems specifically tailored to your process. The Moisture Management System's application interfaces include the following series:

[Open Frame Planar](#) | [Flange Mount](#) | [Sled](#) | [Pipeline](#) | [Sampling](#)

# RF Moisture Management Systems

Sensortech offers two management systems for the Planar Open Frame, Flange Mount, Sled, Pipeline, and Sampling Series of RF Moisture Application Interfaces; the ST-2200A and the ST-3300. Both management systems provide an advanced level of moisture management and control and will suit your production process needs depending upon your manufacturing environment and requirements.

## MOISTURE MANAGEMENT SYSTEM | ST-2200A & ST-3300 CENTRAL COMPONENTS

### Application Interface

The RF Sensor (Antenna) provides the source of the Radio Frequency Dielectric Measurement using one of over forty adapted housings suited to your specific application.

### Sensor Electronics

A NEMA12 rated metal enclosure contains the moisture measurement and RF switching electronics that is used to collect the signal received from the Application Interface. It is housed separately from the Application Interface allowing the Management System to operate in harsh environments.

### Attached Electronics

Particular applications requiring high sensitivity will use an Application Interface housing having an Attached Sensor Electronics enclosure. These Application Interfaces combine the RF Sensor with the Sensor Electronics to form a single component of the Management System.

### Processor Unit

An intelligent measurement and control unit that connects to the Sensor Electronics and provides moisture measurements via serial communication protocols (RS-232 & RS-485), 4-20mA outputs and the front panel LED display.

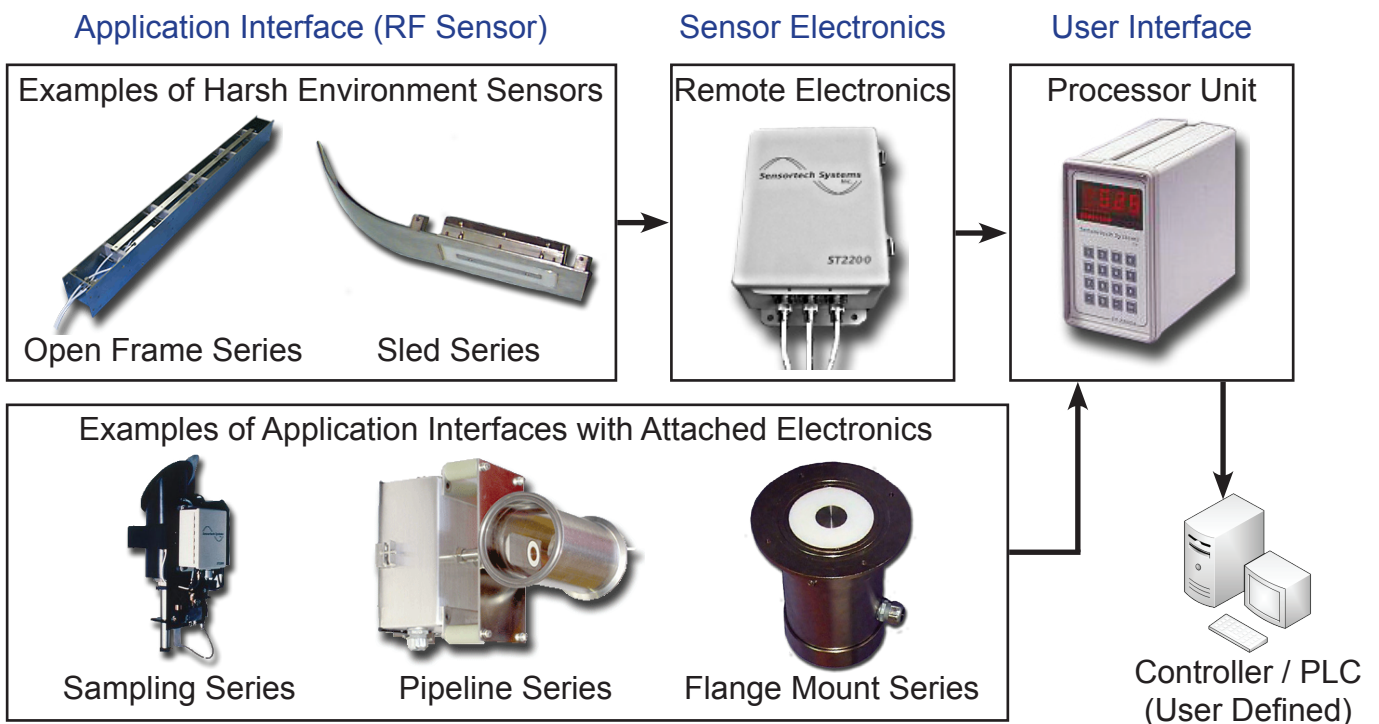

# RF Open Frame Planar Series

The product passes over the sensor where the moisture measurement is taken. The open-frame minimizes buildup of debris by allowing excess product to fall through it and is commonly used for applications having extreme temperatures, excessive vibration, or other harsh environments. Typically used between conveying belts or rollers and In-Kiln locations.



The Open Frame Planar Series is available in standard lengths ranging up to 48 inches in 12 inch increments. Additionally, non-standard lengths are available upon special request.

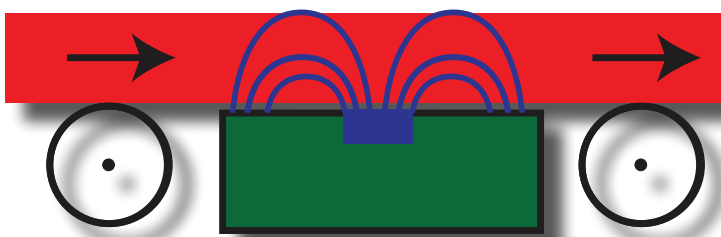

Applications requiring extra sensitivity are available with an Attached Electronics application interface. Minimized cable capacitance achieved through combining the sensor and the electronics produces an effective moisture measurement. Alternatively, separating the sensor and the remote electronics provides the ability to operate in harsh environments.

1000°F (540°C) Ultra High Temp Remote Electronics	High Sensitivity Attached Electronics

# RF Flange Mount Series

## Geometries & Sizes

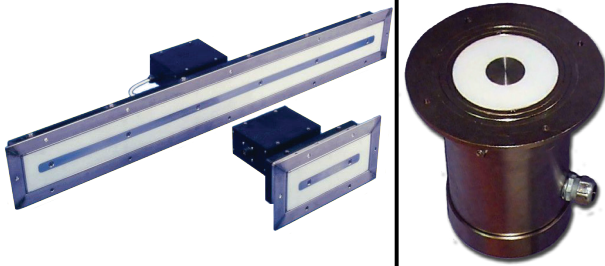

The Flange Mount Series is available in numerous geometries and sizes. These varieties of options give the Flange Mount the versatility of being placed exactly where your moisture measurement is needed.

The product glides on the sealed Teflon or ceramic surface of the sensor where the moisture measurement is taken. The sensor is fixed in place using the flange mount and is placed in critical points throughout your production process. Performs well in high vibration environments and is ideally suited for granular or powdered products. Typically used in bins, hoppers, planar (sloping/vertical/horizontal) surfaces and conveyor drop-off points.



### Conveyor Drop-Off

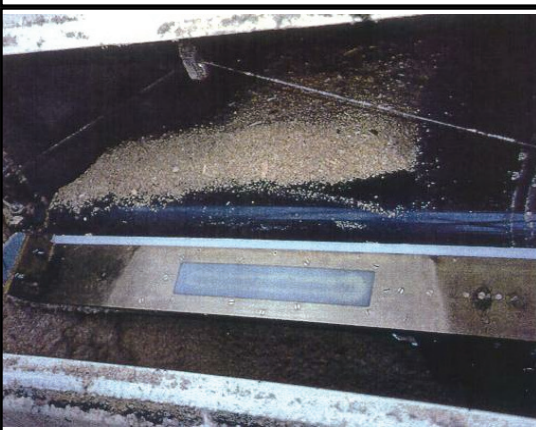

### Vertical Mount



### Hinged Mount







# RF Sled Series

The product passes underneath the sensor where the moisture measurement is taken. The sled hangs from hinged arms allowing it to maintain a parallel position to the conveyor and to level the product for consistent measurement. Maintaining a depth of product greater than the penetration of the RF field is particularly important for the application. Typically used on conveyors (sloping/horizontal).

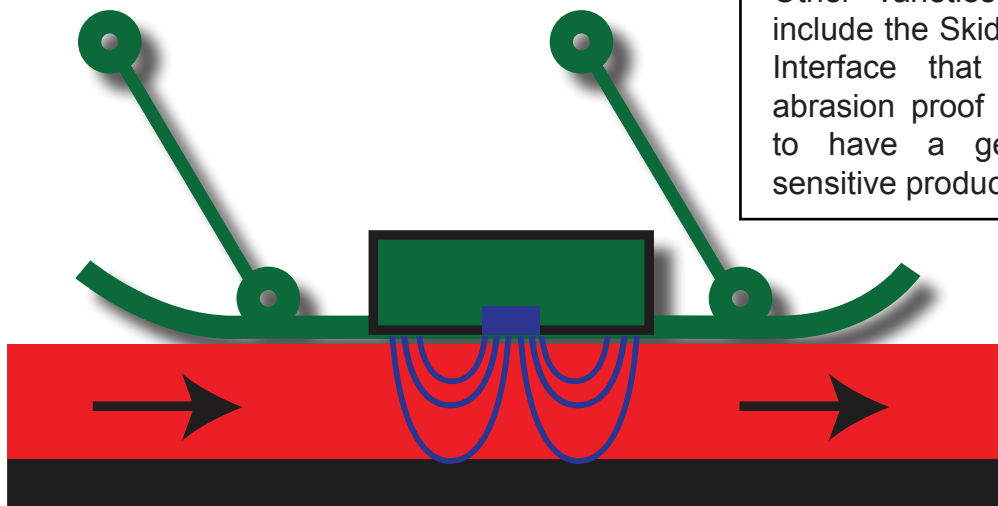
<b>Skid Plate Sensor</b>

Other varieties of Sled Series include the Skid Plate Application Interface that has a smooth abrasion proof surface designed to have a gentle impact on sensitive products.



Harsh Environment	Attached Electronics	Sloping Conveyor
		

# RF Pipeline Series



The product flows through the pipeline where the moisture measurement is taken. The Application Interface is made up of a pipe with attached sensor electronics that is integrated into the pipeline framework of the production process. An optional heater jacket ensures that the product does not solidify. Typically used with production processes manufacturing fluids, pastes, and confectionery applications.

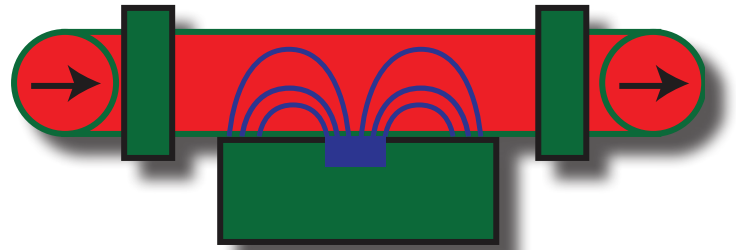

## Coaxial Pipeline



A variation of the Pipeline Series is the Coaxial Pipeline Application Interface which features a center electrode providing a uniform radial field through the product to the pipe wall.

# RF Sampling Series

The product enters a sampling tray or chamber where the moisture measurement is taken. A digital output of the Processor Unit is used to control the fill and purge method of sampling. Sampling Sensors can be found in production processes where a small sample is taken from a large flow of product or where it is not possible to maintain a reasonably constant flow of product over the sensor.

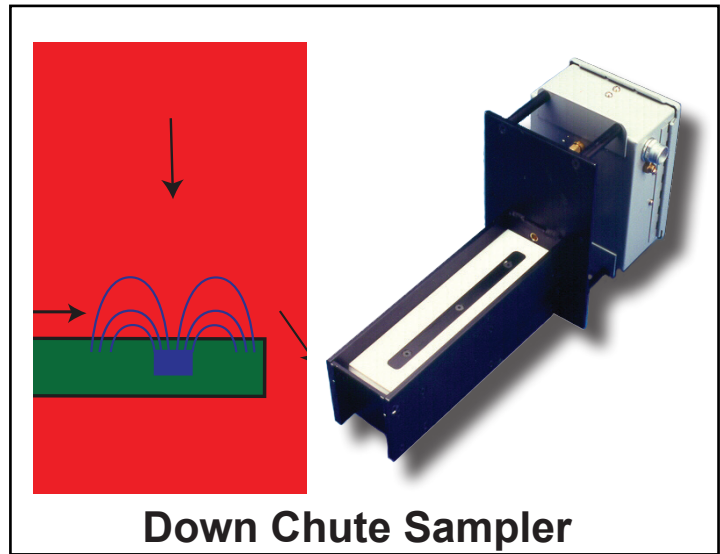

Common types of Sampling Sensors include a Piston Purge, Air Purge, and Down Chute Application Interface that uses different techniques of sampling the product. The Piston Purge Sampling Series utilizes a hydraulic piston mechanism allowing product to enter the sampling chamber for measurement and purging the chamber after the measurement has been taken. Likewise, the Air Purge Sampling Series uses a similar fill and purge technique using compressed air in lieu of the hydraulic piston mechanism. The Down Chute Sampling Series allows product to fall into the sampling tray and purges the product with a blast of compressed air.

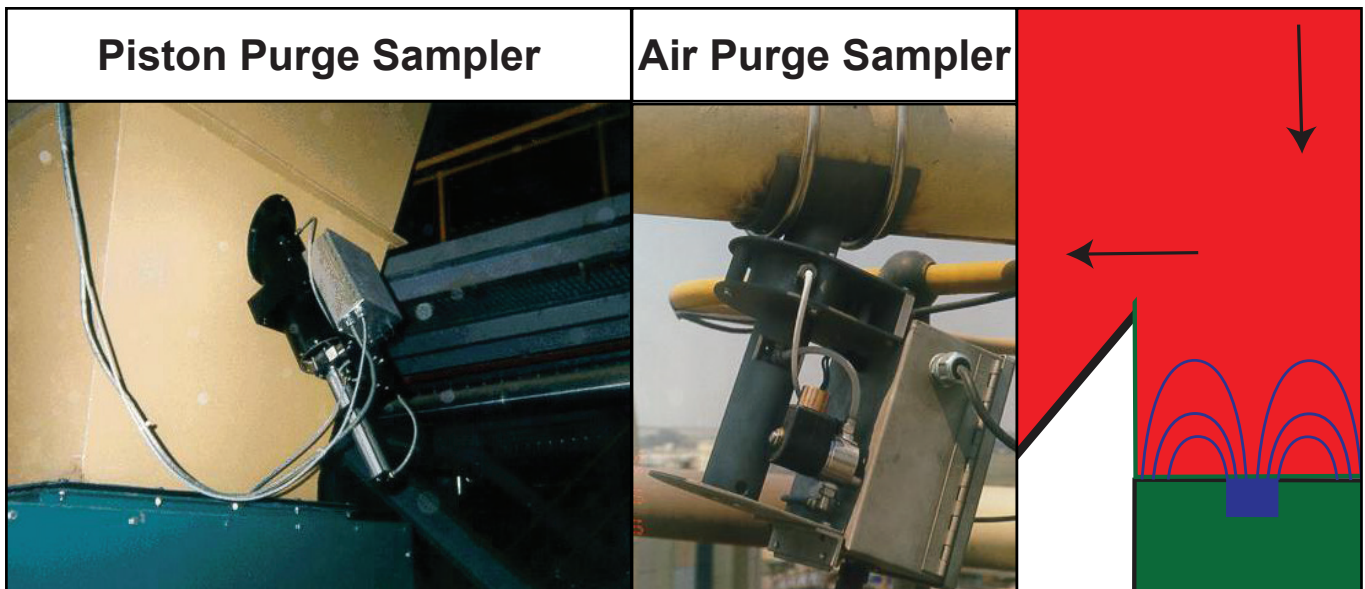



# RF Instant Moisture Profiling System

The IMPS-4400 provides the most advanced level of moisture profiling currently available. Using the non-contact Radio Frequency Dielectric Measurement Technology in an arrayed framework allows the IMPS-4400 to deliver a comprehensive view of your products moisture composition.

Our proprietary software takes process control to superior levels of productivity. Graphical displays allow a full diagnostic view of moisture profiles that identify issues before they become problems. The IMPS-4400 proprietary software is fully customizable allowing its users to switch graphic paradigms and view their processes from a variety of perspectives.

## Proprietary Software

Visualizing your production process with the IMPS-4400 Proprietary Software provides benefits no other moisture management system can offer. The graphical perspectives provided by the IMPS-4400 changes the approach of handling production issues from isolated incidents to comprehensive real-time solutions.

The high volume of data collected by the IMPS-4400 provide a valuable source of data points for effective statistical analysis. The comprehensive benefits gained from employing the IMPS-4400 range from the immediate recognition of issues from the graphical displays to the derived conclusions made from statistical analysis.

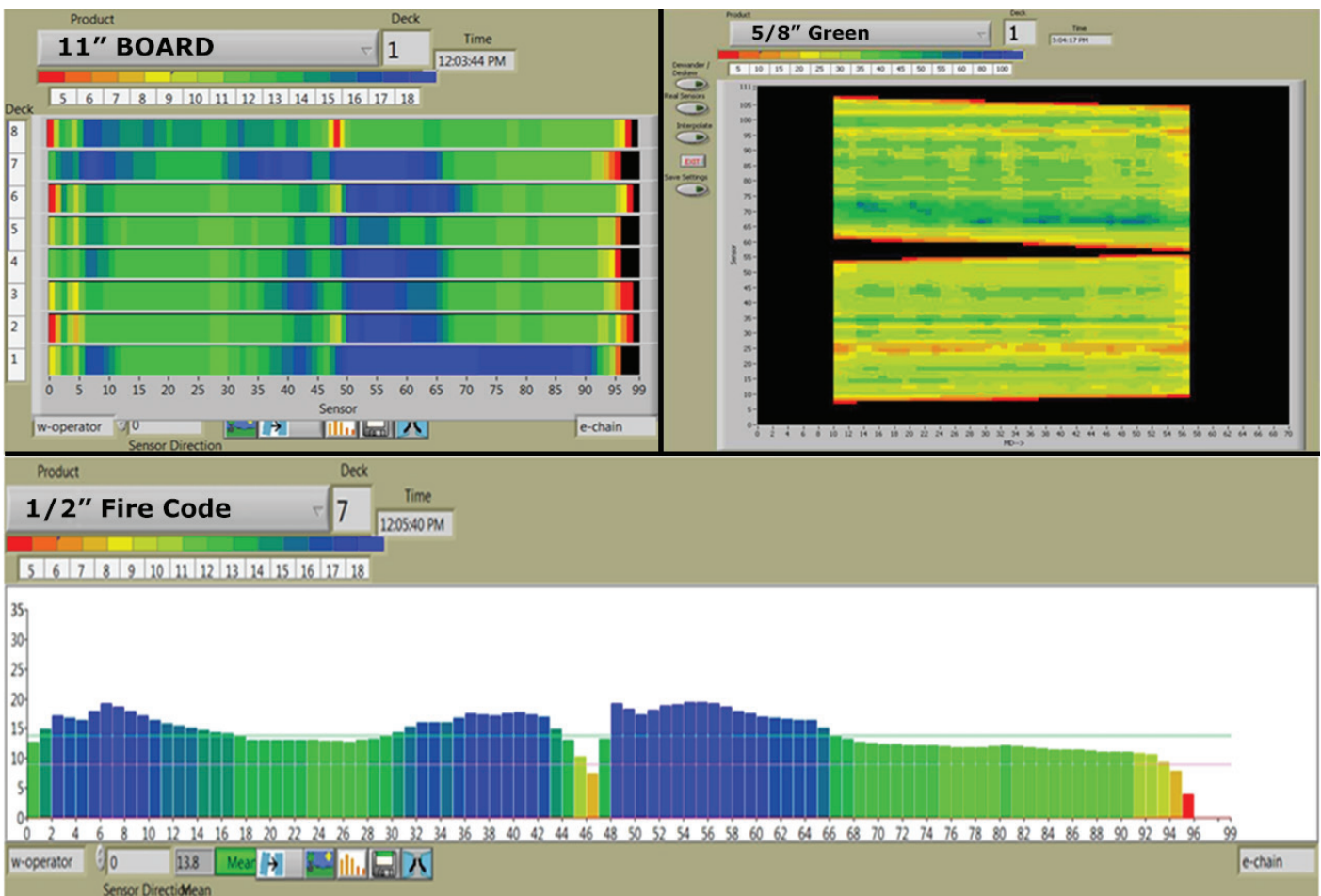

# RF Instant Moisture Profiling System

## INSTANT MOISTURE PROFILING SYSTEM | **IMPS-4400** CENTRAL COMPONENTS

### RF Sensor Array

The RF Sensor Array provides the source of the Radio Frequency Dielectric Measurement. Each sensor has a 2" resolution (50mm) and can be combined to cover a 256" (6.5m) width. This array acts as a collective moisture profiling measurement isolating each sensor's measurement to form a consecutive row of multiple moisture sensors. The IMPS-4400 is not a single moisture sensor but a system containing numerous moisture sensors.

### Data Concentrator

The Data Concentrator multiplexes the data received from the RF Sensor Array and combines this high volume of data at a sample rate of 30mS (33 samples per second). Its intelligent design gives the IMPS-4400 the speed to show the true moisture content of your product in real-time.

### IMPS-4400 Controller

Perhaps the real power of the IMPS-4400 lies within the IMPS-4400 Controller. Graphical representations of data collected from numerous individual sensors using a Radio Frequency Dielectric Measurement are a powerful combination of technologies. Visualizing moisture profiles from a variety of perspectives with the IMPS-4400 proprietary software takes you from a simple moisture measurement to a better understanding of your production process as a whole.

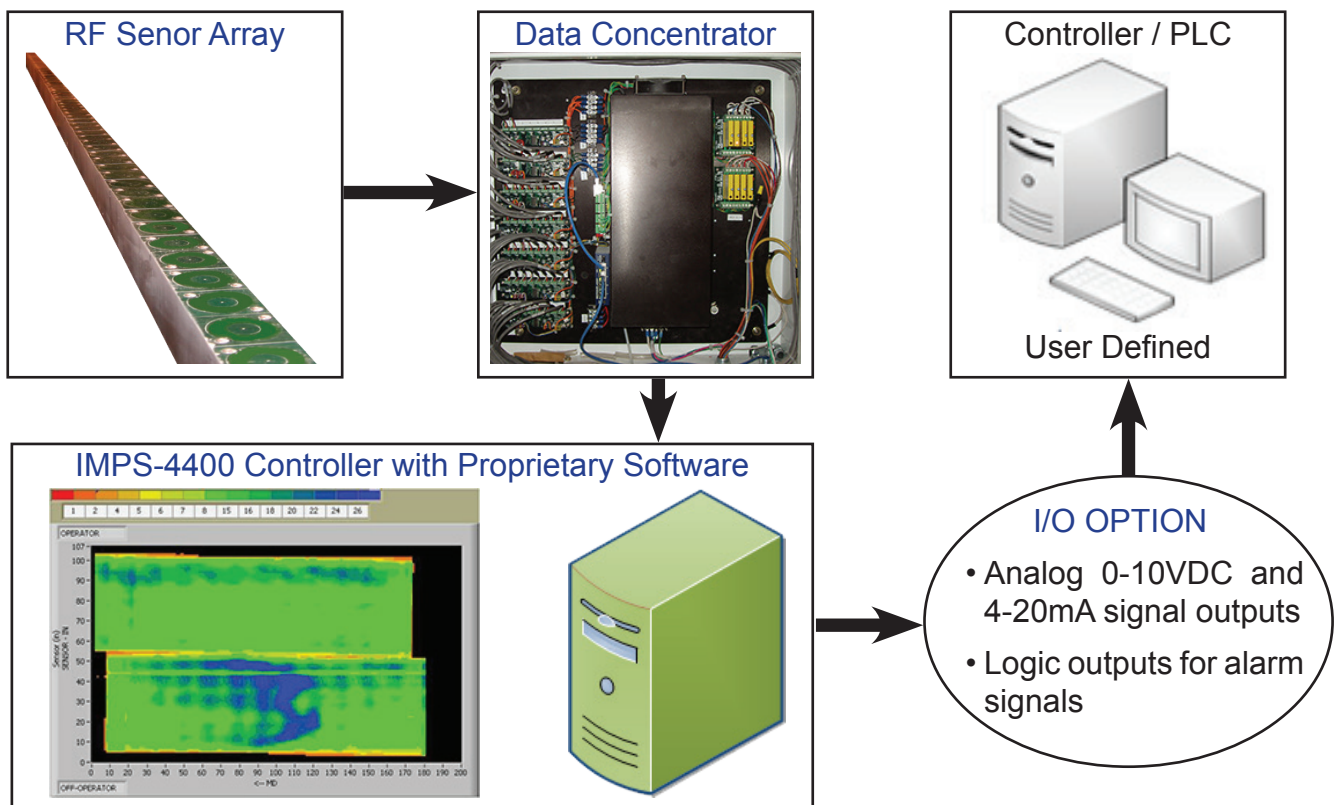

# RF PACKMOIST Laboratory Analyzer



The PACKMOIST Laboratory Moisture Analyzer uses Radio Frequency Dielectric Technology to provide an accurate moisture measurement of 20 cigarettes in their finished state of production. Simply placing a complete pack of cigarettes in PACKMOIST's cylindrical test chamber provides an instant moisture measurement displayed on its Operator Interface.

Prior to PACKMOIST's development the need to test cigarettes in their finished state of production had been accomplished through Near Infrared Reflectance (NIR) laboratory analyzers. This method of testing required manufacturers to carefully remove the tobacco from the cigarette casing and place the contents in its test bed. Providing a simple and non-destructive alternative to this messy and wasteful process was the objective behind PACKMOIST's innovative design.



- Full Pack Average Moisture**
- Cigarette Filter Not Measured**
- Multiple Test Chamber Sizes**
- Non-Destructive Test**
- Instant Results**

# RF Portable Moisture Tester

Portable moisture testers satisfy a variety of needs across the spectrum of manufacturing industries. For more than 30 years Sensortech has been the standard of excellence in RF moisture testing and the latest version of the PMT-330 continues that tradition. It is very likely that you know someone who uses the PMT-330 on a daily basis.

The design of the PMT-330 is based on the technology used in Sensortech's IMPS-4400 and is similar to having a portable version of its advanced technology. Using a Radio Frequency Dielectric Measurement allows the PMT-330 to deeply penetrate the surface of the intended target and receive an accurate measurement of its moisture composition. This is a powerful capability packed into a hand-held device and why it has been the standard of portable moisture testing.



Accurate

Lightweight

Simple Operation

Multiple Calibrations

16-Bit Microprocessor

Ni-MH Rechargeable Battery

## Two Standards of Excellence

### PMT-330G

The PMT-330G is designed for gypsum and other board applications where the effective penetration depth is approximately  $\frac{3}{4}$  inch (20mm).

### PMT-330V

The PMT-330V is designed for veneer and thin sheet applications where the effective penetration depth is approximately  $\frac{1}{8}$  inch (3mm).

# RF Series Options



Sensortech's RF Series of moisture measurement and control systems offer a number of options to optimize each systems performance. The RF Series application interfaces shown to the left are a few examples of options available for the ST-2200A and ST-3300 Moisture Management Systems. The examples below are some of our more popular options:

## ST-2200A

NEMA rated enclosures available to your requirements

Explosion proof enclosures available to your specifications

Thermocouple, RTD, and non-contact IR pyrometer temperature transducers

Optical and mechanical distance transducers

Spare parts kit economically ensures minimum down time

## ST-3300

Remote keyboard and display

Remote button control with indicator LED used to Enable, Zero, and Standardize system

Communication Protocols: PROFIBUS, PROFINET, DeviceNet, EtherNet/IP, Modbus

Product temperature transmitter

Temperature compensation option

## IMPS-4400

NEMA rated enclosures available at your request

Up to 128 individual sensors mounted in an array

Offers real time analog signals providing 0-10VDC and 4-20mA outputs

Logic outputs provide alarm signals indicating user defined levels of moisture and board lengths

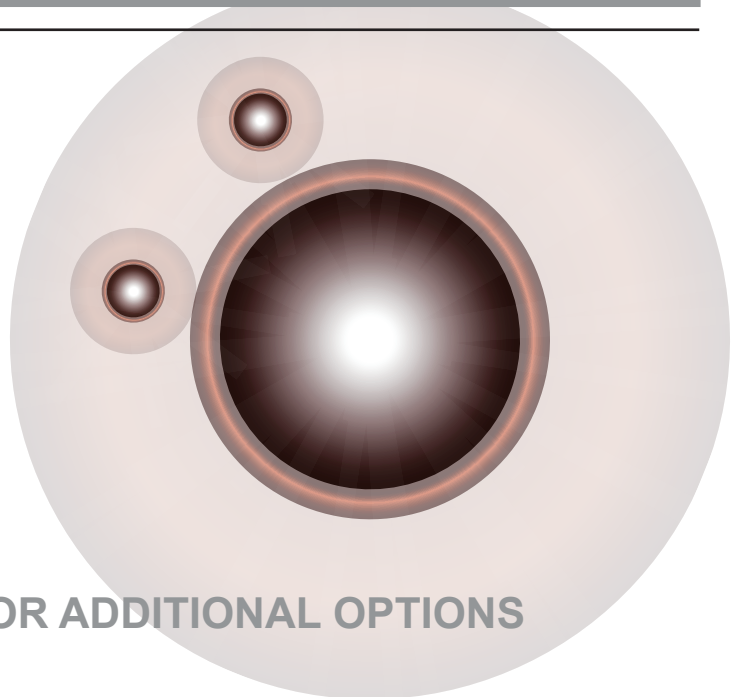

**CONTACT SENSORTECH FOR ADDITIONAL OPTIONS**

# RF Series Specifications

Specifications	ST-2200A	ST-3300
Accuracy (subject to application)	0% - 10% Range ±0.10%	0% - 10% Range ±0.10%
	10% - 30% Range ±0.25%	10% - 30% Range ±0.25%
	30% - 80% Range ±0.50%	30% - 80% Range ±0.50%
Sampling Rate	10mS, 100mS, 1S (selectable)	10mS, 100mS, 1S (selectable)
Sample Averaging	1 - 120 Samples	1 - 120 Samples
Inputs	1 x Dielectric Sensor Input 1 x Product Temp (voltage or current) 1 x Weight (voltage or current) 1 x Distance (voltage or current) Keyboard, Full Function 16 Keypad Sealed Rubber 1 x Isolated Digital Input	1 x Dielectric Sensor Input 1 x Product Temp (voltage or current) n/a n/a n/a 2 x Isolated Digital Input
Outputs	Large (1 in.) Digital LED Readout 1 x 4-20mA Isolated Current Solid State Relays, Hi - Lo Alarms 1 x Digital Output	n/a 2 x 4-20mA Isolated Current n/a 2 x Digital Output
Communication Protocols	RS-232/485 Digital Communications	1 x RS-232/422/485
Optional Protocols		1 x USB (1.0/2.0) 1 x Ethernet TCP/IP UDP (1 of) PROFIBUS, PROFINET, DeviceNet, EtherNet/IP, Modbus
Sensor Electronics	NEMA 12 (higher ratings available)	NEMA 12 (higher ratings available)
User Interface	Processor Unit	OI or User Defined Controller/ PLC
Operating Temp	32 - 120°F (0 - 50°C)	32 - 120°F (0 - 50°C)
Application Interface Specifications		
Mechanical	Various Styles Including: Planar, Sealed Flange Mount, Sled, Pipeline, Sampling, Probes (contact Sensortech for details)	Various Styles Including: Planar, Sealed Flange Mount, Sled, Pipeline, Sampling, Probes (contact Sensortech for details)
Operating Temp	32 - 120°F (0 - 50°C)	32 - 120°F (0 - 50°C)
High Temp	Up to 500°F (260°C)	Up to 500°F (260°C)
Ultra High Temp	Up to 1000°F (540°C)	Up to 1000°F (540°C)

# RF Series Specifications

## IMPS-4400 Specifications

Accuracy (All accuracies subject to application)	0.01%
Moisture Range	0 - 25%
Sampling Rate	33 Samples per Second
Maximum Number of Sensors	128
Maximum Sensor Array Width	256 in. (6.50m)
Operating Temperature	
Sensors	32 - 185°F (0 - 85°C)
Other Components	32 - 122°F (0 - 50°C)
Power	115 / 240VAC (50 / 60Hz)
Sensor Specifications	
Size	2.00 in. (50mm) Sq., 4.50 in. (115mm) L
Mounting	Rigid Mounting Bracket
Data Concentrator Specifications	
Enclosure	NEMA4 Wall-Mount
Dimensions	
Up to 64 Sensors	24 in. x 24 in. x 9 in. (width x height x depth)
Up to 128 Sensors	48 in. x 24 in. x 9 in. (width x height x depth)
Embedded Processor	
Input	Up to 16 Deck ID Signals / 128 Sensors
Output	Ethernet UDP
IMPS-4400 Controller Specifications	
Operating System	Windows 7
Processor Speed, System RAM, Hard Disk Drive	3.30GHz, 2GB, 250GB
CD/DVD Drive	Included
Monitor	19 in. Color Monitor
Keyboard and Mouse	Included
USB Interface	2 Ports (1.0/2.0)
Ethernet Interface	2 Ports (10/100)
Controller Options	
I/O Options	
Moisture Outputs	4 - 20mA, 0 - 10VDC
Alarm Outputs	0 - 5VDC
Enclosure Option	Several NEMA Types Available

# RF Series Specifications

## PACKMOIST Specifications

Accuracy (All accuracies subject to application)	±0.10% Absolute
Display	Large LED Numeric Display with Lower Alphanumeric
Calibrations	Up to 50 Calibrations Stored in Non-Volatile Memory
Operator Interface	Flat Panel PC with Windows CE®
Dimensions	
Operator Interface	9.84 in. x 5.90 in. x 2.95 in. (width x height x depth)
Sensor	3.94 in. x 4.53 in. x 6.50 in. (width x height x depth)
Weight	
Operator Interface	5.51 lbs. (2.5 Kg)
Sensor	4.41 lbs. (2.0 Kg)
Operating Temperature	50 - 86°F (10 - 30°C)

## PMT-330 Specifications

Accuracy (All accuracies subject to application)	±1.0% of Full Scale
Calibrations	Up to 10 Calibrations Stored in Non-Volatile Flash Memory
Display Range	0 - 999
Display	2 - Line x 16 Alphanumeric Back-Lit LCD
Microprocessor	16 - Bit RISC Architecture
Keyboard	Sealed with Tactile Dome Switches
Operating Temperature	32 - 120°F (0 - 50°C)
Operating Time from Full Charge	10 Hours (300 operations @ 2 minute time-out)
Weight	1 lb. (454g)
Dimensions	4.50 in. x 9.00 in. x 2.00 in. (width x height x depth)



# Product Services

## On-Site Services

### User Training

Comprehensive instruction for operators and technical staff requiring advanced training of system operation, maintenance, repair, calibration, standardization, and safety procedures.

A significant portion of the training is focused on the theory and operation of the Sensortech instrument and how it relates to your manufacturing process.

### Product Commissioning

Hardware calibration, system configuration and tuning, and integration into your process are included with this service.

Sensortech partners with your staff to install the instrument and optimize its performance.

### Product Repair

Sensortech will arrange for on-site visits for product repair and technical evaluations.

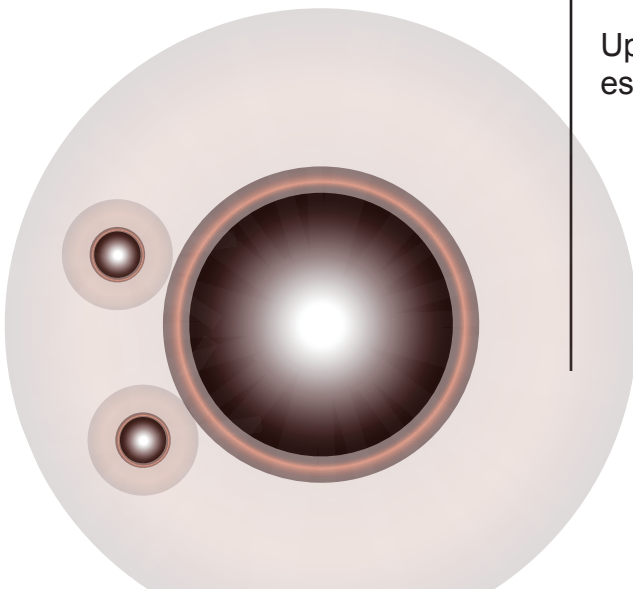

## Factory Services

### Product Calibration

Sensortech provides calibration services at our factory.

Product samples are sent to our calibration laboratory and are calibrated to your specifications.

The instrument is sent to your location ready for installation.

### Technical Support

Sensortech provides technical support for all our instrumentation.

Our staff is eager to provide technical assistance.

This service is provided via phone or email.

### Product Repair

Send your instrument to our facility for a repair evaluation.

Upon evaluation we will provide a cost estimate of repair for your approval.

SENSORTECH SYSTEMS, INC.  
HEADQUARTERS

2221 E. Celsius Avenue, Unit B  
Oxnard, California 93030

United States of America

Phone: (805) 981-3735

Fax: (805) 981-3738

[sales@sensortech.com](mailto:sales@sensortech.com)

[www.sensortech.com](http://www.sensortech.com)

SENSORTECH SYSTEMS  
EUROPE BV

Distributiestraat 27

4283 JN GIESSEN

The Netherlands

Phone: +31(0) 183 445051

Fax: +31(0) 183 445059

[info@sensortechsystems.eu](mailto:info@sensortechsystems.eu)

[www.sensortechsystems.eu](http://www.sensortechsystems.eu)



**The Measurement and Control Company**

© 2015 All Rights Reserved